



ETAP Nuclear Generation Plants

93% of Nuclear Sites Use ETAP

Operation Technology, Inc.

etap.com

info@etap.com

ETAP Nuclear Licenses

The ETAP Nuclear License is used throughout the world by nuclear generation plants, research laboratories, consulting firms, government agencies, etc. Numerous companies such as AREVA, Bechtel Power Corp., URS Washington Division, Black & Veatch, Sargent & Lundy, Washington Savannah River Company and many others trust ETAP for electrical system analysis. For example, Bechtel SAIC Company uses ETAP for the Yucca Mountain nuclear waste repository project in Nevada.

ETAP has established itself as the de facto standard within the United States nuclear generation plants market, so much so that 57 out of 61 operating plants (93%) have standardized on ETAP. ETAP is also becoming the standard software for international nuclear generation plants. In fact, Framatome ANP GmbH in Germany has used ETAP to design the largest grass root nuclear generation plant in Finland.

57 Out of 61 Nuclear Generation Plants Have Standardized on ETAP

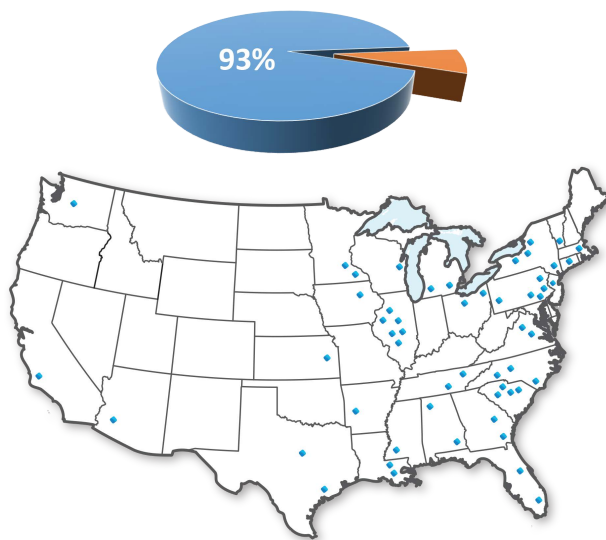

- Alvin W. Volgtle
- Arkansas Nuclear One
- Beaver Valley
- Braidwood
- Browns Ferry
- Brunswick
- Byron
- Calvert Cliffs
- Catawba
- Clinton
- Columbia Generating Station
- Comanche Peak
- Davis-Besse
- Diablo Canyon
- Donald C. Cook
- Dresden
- Duane Arnold
- Edwin 1 Hatch
- Fermi
- Grand Gulf
- Hope Creek
- Indian Point
- James A. Fitzpatrick
- Joseph M. Farley
- Kewaunee LaSalle
- County Limerick
- McGuire
- Millstone
- Monticello
- Nine Mile Point
- North Anna
- Oconee
- Oyster Creek Palo Verde Peach Bottom
- Perry
- Pilgrim
- Point Beach
- Prairie Island
- Quad Cities
- R.E. Ginna
- River Bend
- Robinson
- Salem
- San Onofre
- Seabrook
- Sequoyah
- Shearon Harris
- South Texas Project
- St. Lucie
- Surry
- Susquehanna
- Three Mile Island
- Turkey Point
- V.C. Summer
- Waterford 3
- Watts Bar
- Wolf Creek

International Nuclear Projects Rely on ETAP

ETAP is also the standard software for nuclear companies around the world. In fact, ETAP is currently being used to design the largest grass root nuclear generation plant in Finland. The ITER Organization is using ETAP in Cadarache, France for the design and analysis of the world's largest experimental site to demonstrate the scientific and technical feasibility of fusion power. Countries using ETAP for nuclear projects include:

Argentina	Finland	India	South Korea
Canada	France	Italy	Spain
China	Germany	Japan	Taiwan

Why ETAP for Nuclear Facilities

- Established and credible High Impact Quality Assurance Program Since 1991
- Complete Software and Library Verification & Validation in compliance with Title 10 Part 50, Appendix B and Part 21
- Receive formal notification of in-depth exception listing of performance
- Most commonly used analysis software in US nuclear power plants
- Unique capabilities with unsurpassed user-friendliness
- State-of-the-art software and engineering technology
- All development and technical support provided by ETAP engineers (OTI Corporate Office)



Benefits of Using ETAP

- Eliminate man-hours and expense of internal software validation
- Gain proof of software and libraries accuracy with minimal investment
- Receive updated documentation of ongoing audits of ETAP
- Operate your system with a virtual reality model concept
- Gain more understanding of your system limitations
- Manage system modifications in one integrated database
- Have a team of experts for support
- Avoid unnecessary system upgrade Costs

ETAP Meets Nuclear Facility Requests

1) High-Impact Safety Related Software & Library Data

With a non-safety related software, nuclear facilities have to spend a tremendous amount of time and money to dedicate a specific version of the software before using it. Engineers are forced to use an obsolete program because the cost of rededicating a new release is so high. Furthermore, engineers are unable to take advantage of the latest advancements in software, engineering, optimizations, and numerical calculation techniques.

ETAP nuclear customers receive Verified & Validated software on a regular basis, so facilities don't have to spend time and money for internal validation. ETAP is Verified & Validated against field results, real system measurements, established programs, and hand calculations in order to ensure its technical accuracy. Accordingly, engineers use the latest version of ETAP with the newest features and powerful enhancements. Each release of ETAP undergoes a complete V&V process using hundreds of test cases for each and every calculation module. Figure 1 depicts the pass/fail criterion for the device library data entered into ETAP.

Library	% Deviation	
	Data	TCC Curve
Fuse	0	≤ 1
Points-Based Relay	0	≤ 3
Equation-Based Relay	0	0
Low Voltage Solid-State Trip (LVSST)	0	≤ 3
MV Solid-State Trip (MVSST)	0	≤ 1
Thermal Magnetic (TM)	0	≤ 3
Motor Circuit Protector (MCP)	0	≤ 3
Electro-Mechanical (EM)	0	≤ 3
Overload Heater (OLH)	0	≤ 3
All Other Libraries	0	N/A

Figure 1. ETAP Library Pass/Fail Criterion

Visit http://www.etap.com/ga_casedocs.htm to view a sample of test cases that are indicative of the type of tests performed for each analysis.

In addition, engineers benefit from the ongoing QA audits by other facilities including NUPIC members. Qualified auditors periodically assess the program in order to detect any deviations from the complied standards and evaluate effectiveness of the existing plans and procedures.

2) QA Standards

Verification & Validation procedures for each nuclear release are in full compliance with the following standards:

- **United States Code of Federal Regulation, Title 10 CFR Part 50, Appendix B**
Quality Assurance Criteria for Nuclear Power Plants and Fuel Reprocessing Plants
- **United States Code of Federal Regulation, Title 10 CFR Part 21**
Reporting of Defects and Noncompliance
- **United States Code of Federal Regulation, Title 10 CFR Part 50.55**
Condition of Construction Permits, Early Site Permits, Combined Licenses, and Manufacturing Licenses
- **ANSI / ASME N45.2 - 1977**
Quality Assurance Program Requirements for Nuclear Facilities
- **ASME NQA-1 (includes Subpart 2.7)**
Quality Assurance Requirements for Nuclear Facility Applications
- **ISO 9001:2008 Standards**
Quality Management Systems - Requirements
- **ANSI / IEEE 730.1 - 1989**
IEEE Standard for Software Quality Assurance Plans
- **CAN / CSA-Q 396.1.2 - 1989**
Quality Assurance Program for Previously Developed Software Used in Critical Applications
- **ANSI N45.22 - 1972**
Packaging, Shipping, Receiving, Storage, and Handling of Items for Nuclear Power Plants



3) Contents of Safety-Related (High-Impact) Nuclear Version of ETAP

The Safety-Related (High-Impact) Nuclear version of ETAP includes:

- Certification Letter
- Software Requirements Specification (SRS)
- Software Verification & Validation Plan (SVVP)
- Software Verification & Validation Report (SVVR)
- Test Files & Output Report Files in an Electronic Format
 - i. QA Documents – 103 3” binders of Specs, Reports, Audits, etc.
 - ii. V&V Documents – 1000s of test cases (4 GB of electronic files)
- Opportunity to Audit & Assess OTI’s Quality System
- Error Reporting of Defects and Noncompliance



The thoroughness of the Quality Assurance Plan has not only helped OTI to become a nuclear certified software developer, it has set an unmatched standard of quality that has earned the trust of thousands of ETAP software users worldwide.

Our QA procedures are deeply ingrained in all phases of the design and development of ETAP. These inherent QA processes drive us to envision and market a more powerful and innovative engineering software with each version we release.

Comprehensive error reports of defects and noncompliance per U.S. Title 10 CFR, Part 21 provides nuclear users access to discrepancies. Informative reports clearly define impact of noncompliance on the nuclear plant. As a result of our commitment to QA, there have been zero Part 21 reports since 1991.

	Commercial	Advantage	Nuclear
ETAP Software	✓	✓	✓
ETAP Libraries	✓	✓	✓
ETAP User Guide & Help	✓	✓	✓
ETAP QA Compliance	ISO 9001:2008	✓	✓
	Title 10 CFR 50, Appendix B	✓	✓
	Title 10 CFR Part 50.55	✓	✓
	Title 10 CFR Part 21	✓	✓
	ANSI/ASME N45.2	✓	✓
	ASME NQA-1	✓	✓
	ANSI/IEEE Std. 730.1	✓	✓
	CAN/CSA-Q 396.1.2	✓	✓
ANSI N45.2.2	✓	✓	
Verification & Validation Certification Letter		✓	✓
Performance Reporting		✓	✓
Nuclear Certification Letter			✓
Verification & Validation Documentation			✓
Verification & Validation Test Cases			✓
OTI Onsite Audits			✓
Annual Nuclear Conference			✓
Annual Nuclear Symposium			✓



4) ETAP Quality Assurance Audits

In accordance with OTI's Quality Assurance Program, all procedures and activities related to the quality of ETAP software are subject to audits. Qualified auditors periodically assess the program in order to detect any deviations from the complied standards and evaluate effectiveness of the existing plans and procedures.

Audit reports are properly documented and are subject to audits conducted by our nuclear clients and ISO 9001:2000 certification assessments.

We are currently on the supplier list of many nuclear facilities and NUPIC members. The purchase of a nuclear package allows our users to periodically assess our quality system. OTI's Quality Assurance Program has undergone numerous audits since 1991. Currently, our clients audit our program several times a year. All audits have resulted in continuous compliance.

Audit of ETAP Activities

As part of the ETAP nuclear package, user has full access to perform audit of all ETAP design, development, and test activities. This includes the following documents:

OTI's Quality Assurance Plans & Procedures	Test Plan (TP)
Modification Requests (MR)	Test Design Specification (TDS)
Design & Development Planning (DDP)	Test Design Specification Review (TDSR)
Software Requirements Specification (SRS)	Test Case Specification (TCS)
Software Requirements Specification (SRR)	Test Procedure Specification (TPS)
User Documentation (UD)	Test Case Benchmark (TCB)
User Interface Description (UID)	Test Log (TL)
Software Design Description (SDD)	Test Summary Report (TSR)
Object Model (OM) & Class Diagram (CD)	Software V&V Report (SVVR)
Event Trace (ET)	Functional Audit (FA) & Physical Audit (PA)
Preliminary Design Review (PDR)	Records Audit
Critical Design Review (CDR)	Post Mortem Review
Incident Reports (IR)	Internal Audits(IA)
Error Reporting	Software Configuration Management Plan (SCMP)
Software Verification & Validation Plan (SVVP)	Software Quality Management Review (SQMR)
Software Verification & Validation Plan Review (SVVPR)	Personnel Training

5) Industry Standard for Large Consulting Firms

Not only is ETAP the industry standard for nuclear power plants, it is also the industry standard for the consulting firms that support nuclear power plants. Firms such as Bechtel, Black & Veatch, Duke Engineering, The Washington Group (formerly Raytheon), and Sargent & Lundy use ETAP to provide engineering consulting services and support to nuclear facilities. According to Electrical Construction & Maintenance (EC&M) Magazine, **100% of the top ten design firms rely on ETAP** for their power system design and analysis needs and **80% have standardized on ETAP**.

6) Supported by a Team of Technical Experts

ETAP reduces the technical burden of its users by providing intelligent software backed by a team of engineers, experts, and scientists to support them. ETAP provides each user with the latest technical knowledge on a broad range of engineering issues in design, analysis, applications, and control of power systems.

7) Save Money in Design and Operation of Your System

Using only one database, ETAP tracks hundreds of system configurations in your as-built system as well as future system modifications and changes. Reporting features in ETAP dramatically reduce the paperwork needed to justify your engineering decisions. Ask OTI for a copy of the Tennessee Valley Authority (TVA) Case Study.



8) Largest Directly Employed Staff in Its Industry

OTI directly employs one of the largest staffs of scientists and engineers. We have two R&D offices as well as over 70 sales and support centers around the world to support your engineering needs.

9) Database Conversion Programs to ETAP

OTI offers a suite of database conversion programs that includes other analysis software as well as generic files/formats such as IEEE, Microsoft Access, and Microsoft Excel. Database conversion consists of data transfer, data validation, result comparison, one-line diagram auto-generation, and one-line diagram reconfiguration. New conversion programs can be customized to meet your needs.

10) Unique Technologies Tailored to Nuclear Facilities

Additional nuclear safety-related features and capabilities of ETAP.

➤ User Access Management and Password Protection

ETAP provides nine access levels for each user. Password protection of each user ensures proper design verification.

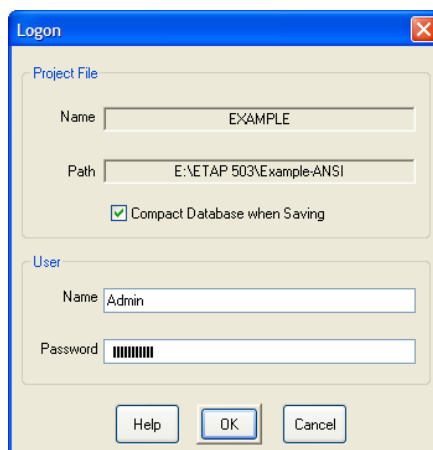
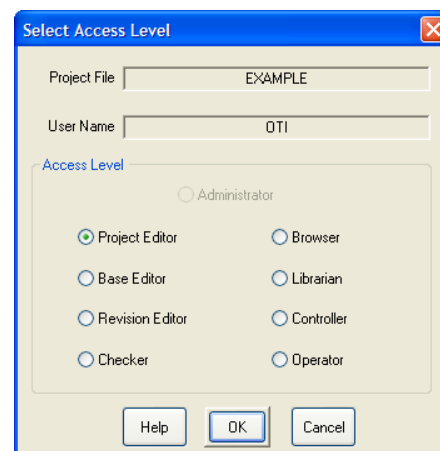
➤ **Revision Control and Management**

ETAP allows for different revisions of the engineering data associated with each element. Only users with proper access levels are permitted to edit the **Base Data** (as-built). **Revision Data** (future modifications, what-if contingencies, etc.) can be merged into the Base Data on user command either individually or based on Change # or Group #. Password and user access control provides a valuable tool for the management of revision data.

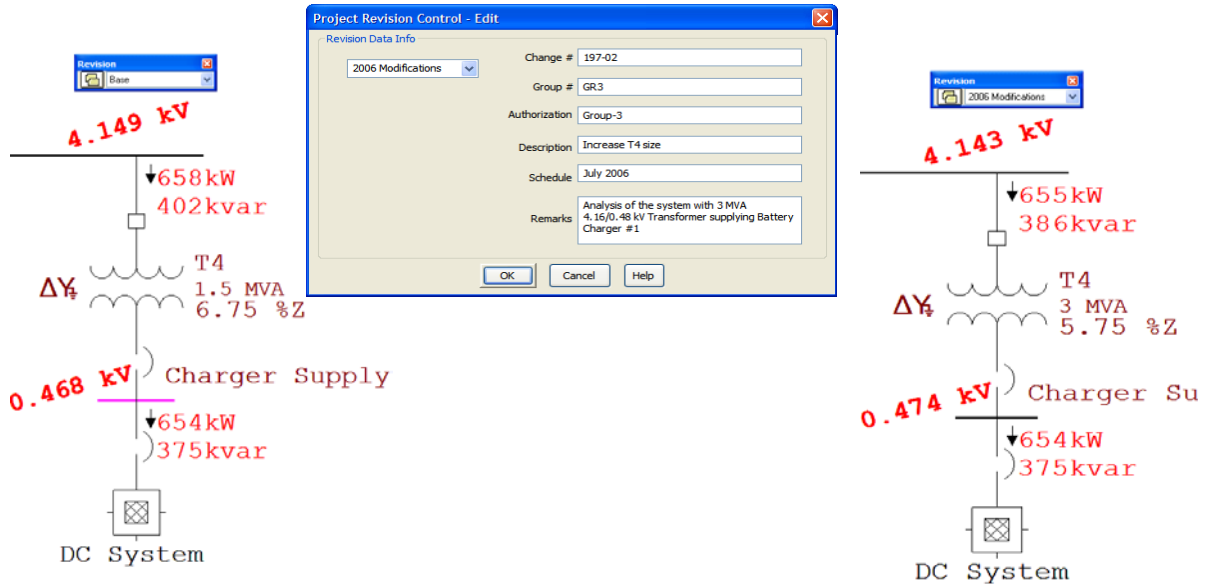

➤ **Data Verification**

All engineering properties can be verified and documented directly in ETAP by invoking the Checker access level. ETAP **time-stamps** the user ID of the Editor (who last edited the project). ETAP also **time-stamps the** user ID of the Checker (who last checked the data) and marks fields to be verified in Red.

Induction Machine Editor - Pump 1

Start Cat	Cable/Vd	Cable Amp	Reliability	Remarks	Comment	
Info	Nameplate	Model	Inertia	Protection	Load Model	Start Dev
1	500 HP 4 kV	3-1/C	350 AWG/kcmil	5 kV		

Ratings

HP: 500, kV: 4, % PF: 91.09, 89.25, 83.98, % Slip: 1.26, Poles: 4

kVA: 447, FLA: 64.52, % Eff: 91.57, 95.68, 96.8, RPM: 1777, RPM: 1800

Loading

Loading Category	% Loading	Motor Load		Feeder Loss	
		kW	kvar	kW	kvar
1 Design	100	407.2	184.4	0.29	0.43
2 Brake	87	345.2	166.4	0.22	0.31
3 Full Load	45	172.9	116.6	0.06	0.09
4 Summer Load	28	106.8	81.91	0.03	0.04
5 Winter Load	0	0	0	0	0
6 Start Up	0	0	0	0	0
7 Emergency	45	172.9	116.6	0.06	0.09
8 Shutdown	0	0	0	0	0

Operating Load: 0 kW +/- 0 kvar

Checking Information

Log off Help

Pump 1

Edited by: OTI, Date: 03-21-2005

Checked by: ETAP, Date: 09-27-2004

Project checked

Filter by: Element Type, All AC Elements, Skip Checked Elements, Date

Display Editors checked

Pump 1

Check All

Check button actions only apply to item in the selector

➤ **Library Validation & Verification**

All engineering and coordination libraries are **validated & verified** for high-impact, nuclear use. OTI adds and validates new library data to ETAP at no charge upon user request. ETAP libraries are part of the controlled data file verification system. All ETAP libraries include the time-stamp and user ID of anyone that modifies the library entries. Unique lock  functionality ensures that verified and validated library information is not changed accidentally.

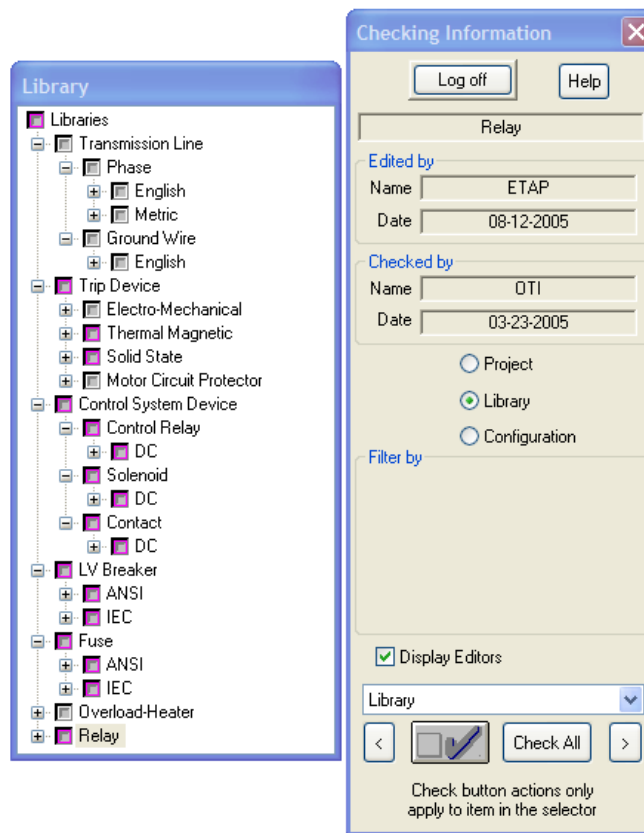

➤ **Unlimited Presentations**

Each facility has the ability to customize multiple one-line diagram presentations with different graphical representations. The appearance of each one-line diagram may seem drastically different from one another, yet all presentations share a common database. You can activate the most suitable presentation at any time to convey your findings.

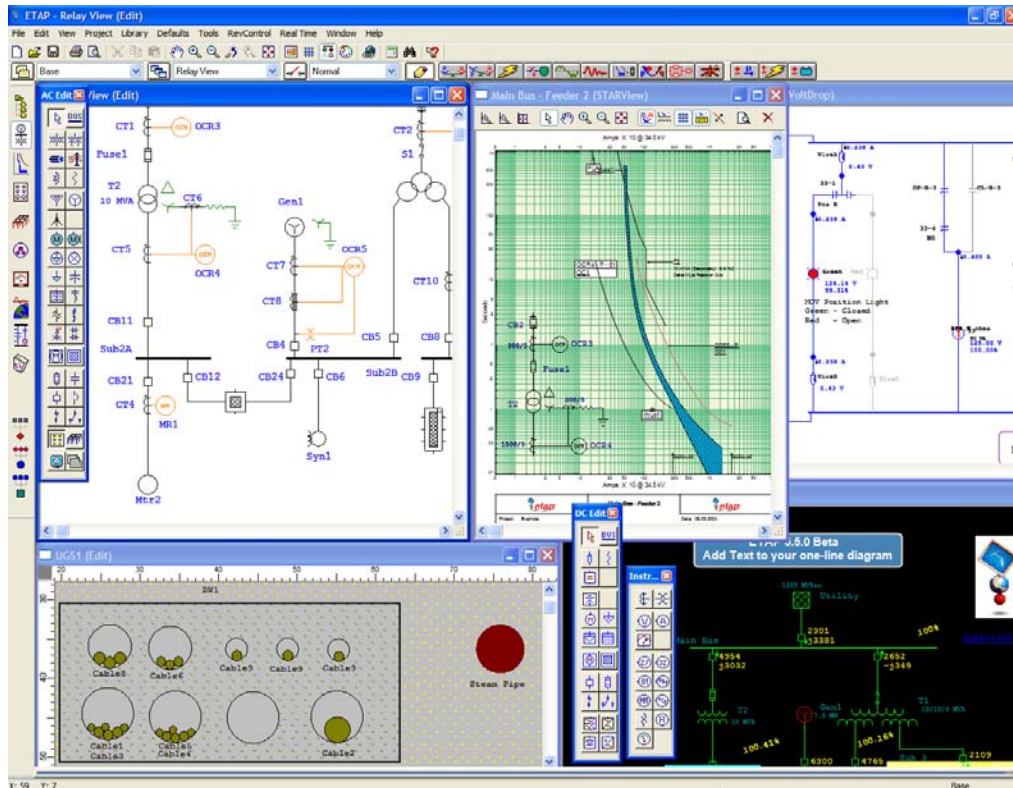

➤ **Unlimited Configurations**

ETAP allows you to have an unlimited number of system configurations, each indicating a different status of circuit breakers, fuses, motors, and loads. Conveniently, when you add a new element or modify engineering properties of the system, changes are saved in all configurations. Configuration Manager allows you to quickly view and change status of switching devices. Convenient **difference** function allows you to quickly identify differences in status.

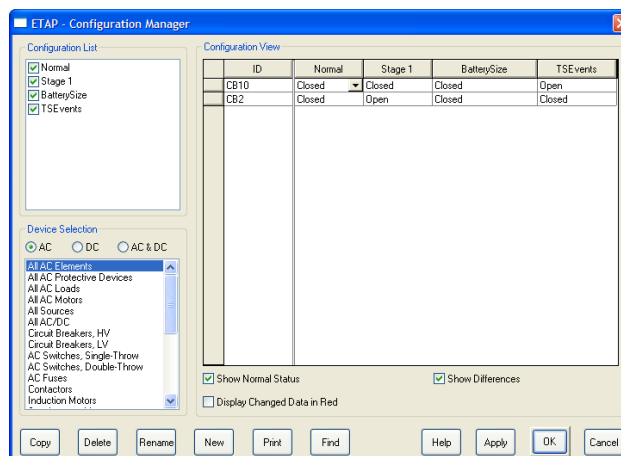

➤ **Unlimited Study Cases**

You can manage multiple study cases, switching between different study options, without the trouble of resetting study and solution parameters. This feature helps you to organize your study efforts and save you time.

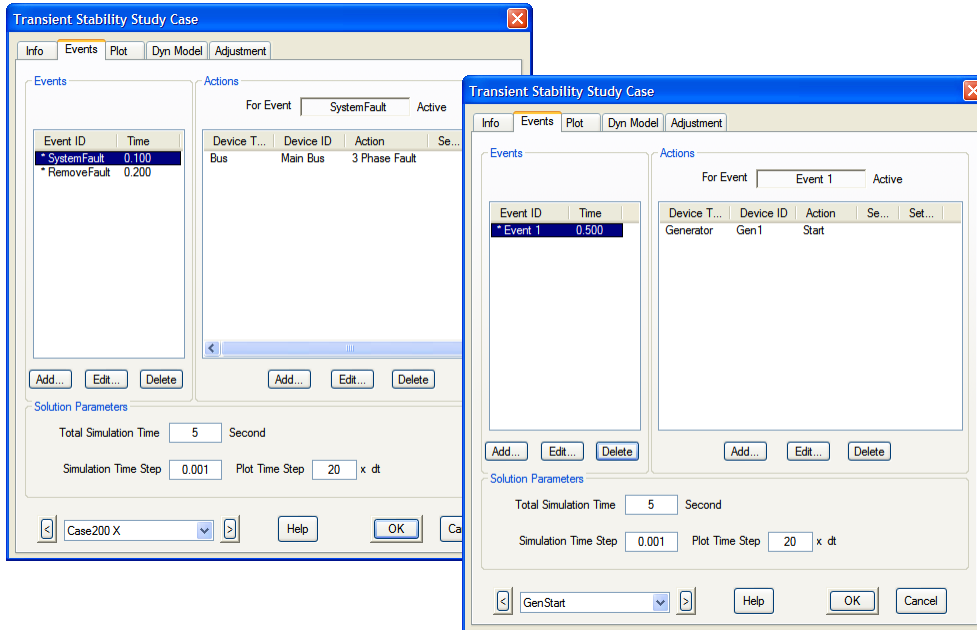

➤ **Loading Categories**

ETAP provides **multiple loading conditions** for each motor and load. You can assign a different percent loading for each user-defined loading category.

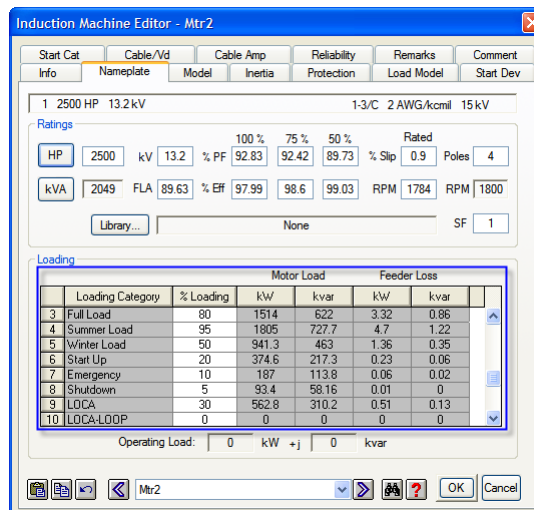

➤ **Generation Categories**

ETAP provides **multiple generation conditions** for each generator and utility connection. You can assign a different percent generation for each user-defined generation category.

➤ **Starting Categories**

Use starting categories to manage the group start of motors simultaneously or at different times. Multiple starting categories are provided for various conditions such as shutdown, emergency, LOCA, etc. Sequence motors and loads to start or shut down at different times.

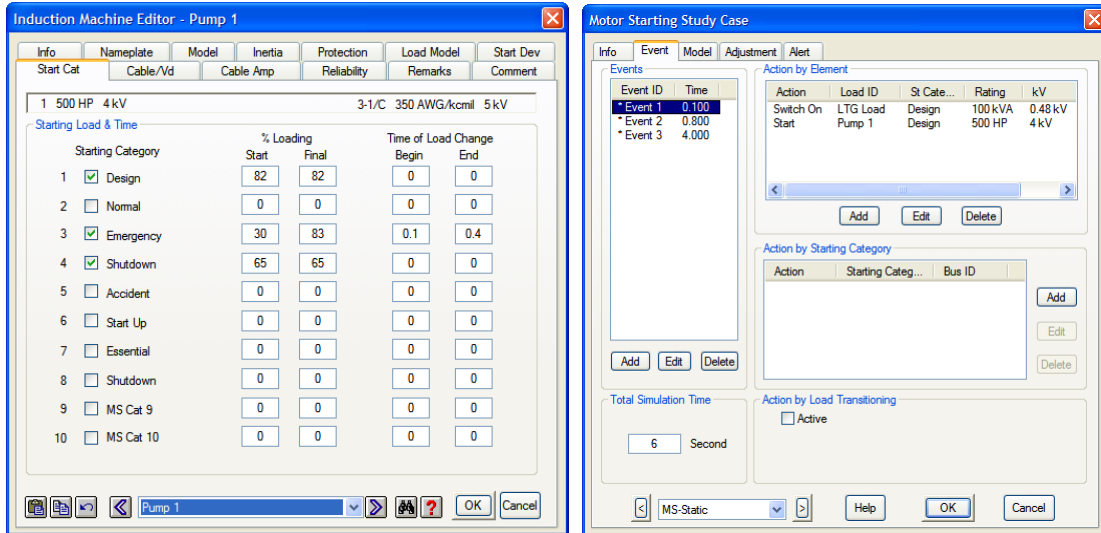

➤ **Motor Operated Valves (MOV)**

ETAP includes specific models and operation functionalities for **MOV**s. This includes MOV operation during all relevant calculations including opening and closing options for motor starting dynamic analysis. Alerts are generated automatically when voltages drop below threshold value.

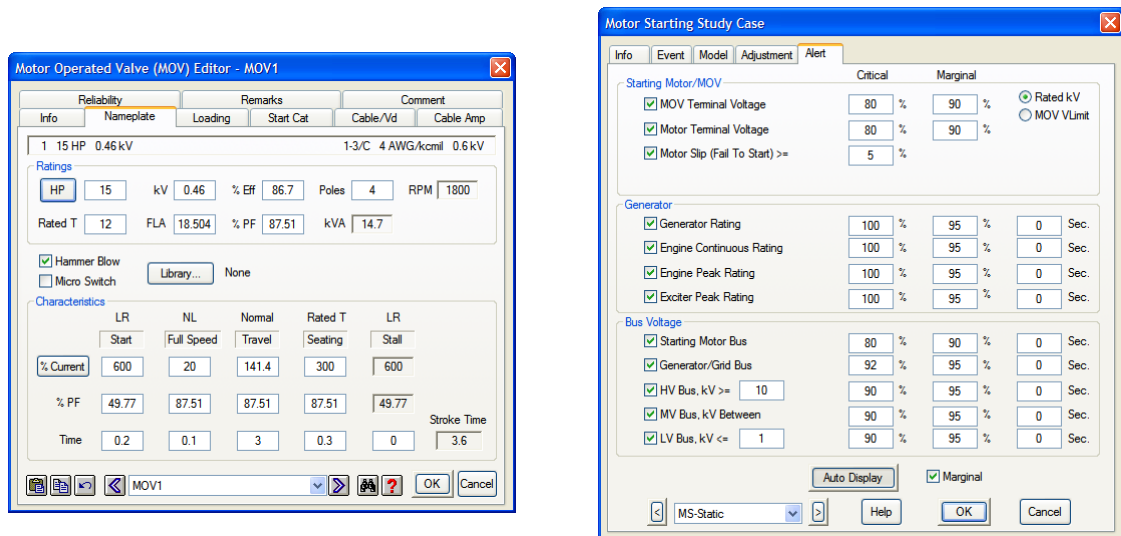

➤ **Integrated DC Analysis**

Model integrated AC and DC networks within a single ETAP database and perform **DC Load Flow**, **DC Short-Circuit**, and **Battery Sizing** analyses. ETAP includes a detailed library of battery makes and models.

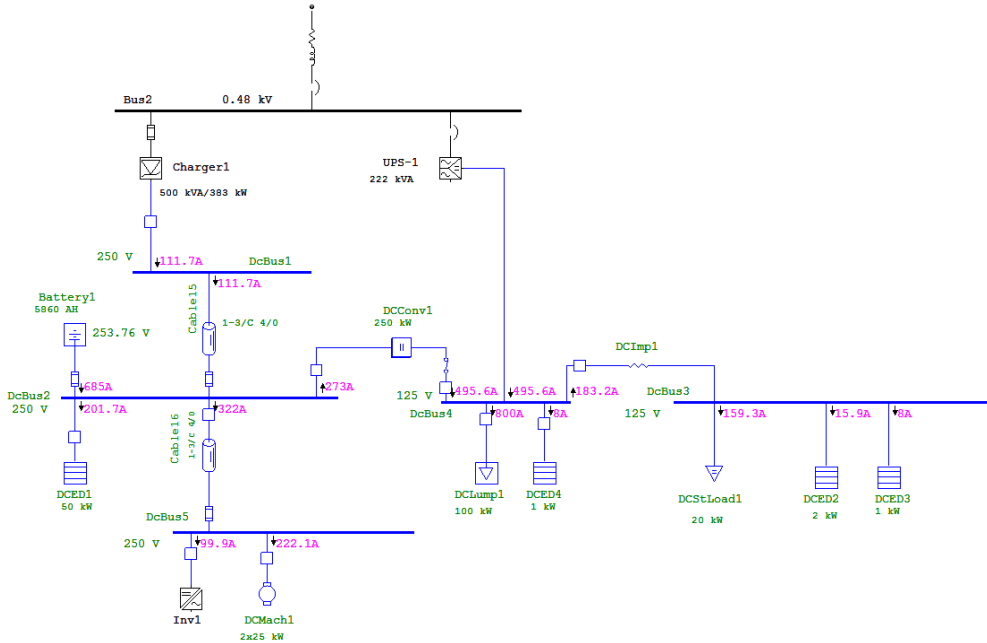

➤ **Control Circuit Diagram**

ETAP seamlessly integrates the analysis of power and control circuits within one electrical analysis program.

The Control System Diagram (CSD) simulates the sequence-of-operation of control devices such as solenoids, relays, controlled contacts, multi-sequence contacts, and actuators including inrush conditions.

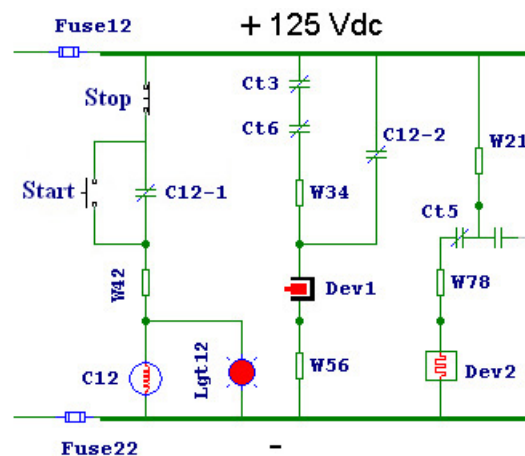

➤ **Cable Sizing for Cable Trays Based on Appendix R Compliance**

In addition to the **NEC** and **ICEA-P-54-440** methods, ETAP includes cable sizing specifically designed for the nuclear industry based on **10 CFR50 Appendix R** compliance for fire protection. This includes expandable libraries for cable ampacity adjustment factors for a variety of fire protection materials including fire wraps, fire stops, and fire coating.

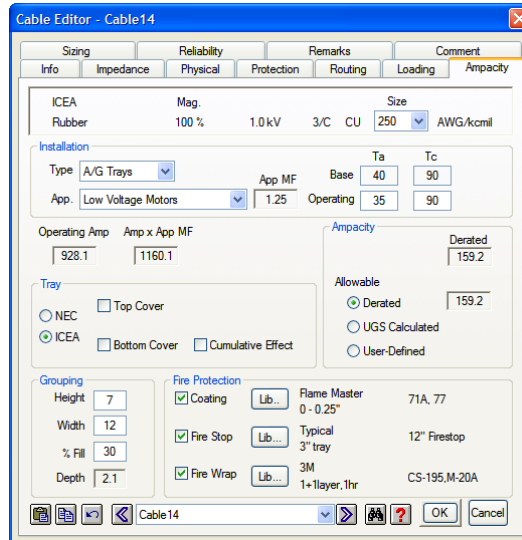

➤ **Generator Start-Up**

ETAP includes **Frequency-Dependent Generator Start-Up** analysis. ETAP contains dynamic exciter/AVR and governor/turbine models, enabling you to start backup diesel generators. Using full frequency-dependent machine and network models, the Generator Start-Up module analyzes cold-state starting of generators under normal and emergency conditions.

The entire generator start-up process is modeled, including automatic control relay simulation and the dynamic behavior of exciters/AVRs, governors, turbines, and Power System Stabilizers (PSS). You can simulate the starting of generators, connection of generators to the network before reaching synchronizing speed, acceleration of motors, action of MOVs, and operation circuit breakers.

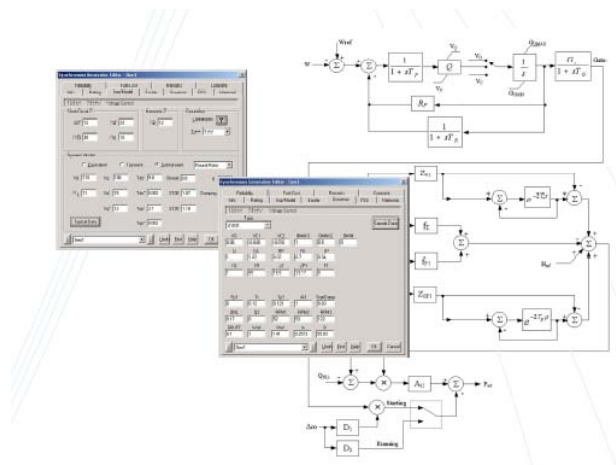

➤ **Underground Raceway Cable Analysis**

ETAP provides as-built cable ampacity analysis for cables routed in underground duct banks. Based on the **Neher-McGrath** method, cable temperatures are calculated based on the heat from other cables, external heat sources, other duct banks, and direct buried conduits. Analysis includes optimization modules such as uniform ampacity calculations and cable sizing.

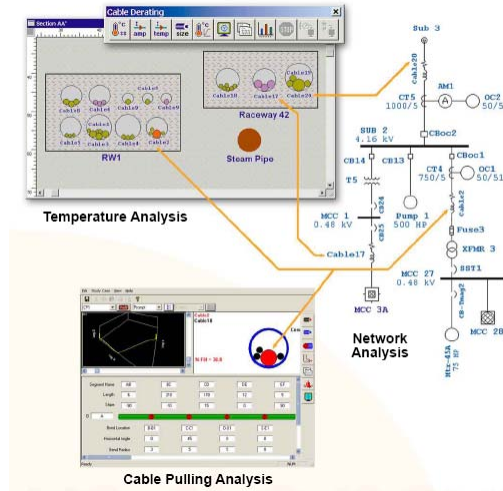

➤ **Protective Relay Operation**

Transient Stability analysis includes modeling of voltage and frequency relays for **system islanding, automatic load shedding and fast bus transfer**. Relays can have unlimited interlocks with trip settings in actual values (volts, hertz) or rate-of-change (volts/hertz, hertz/second).

➤ **Arc Flash Analysis**

Arc Flash Analysis estimates the arc flash incident energy under a bolted three-phase short circuit fault and determines the flash protective boundary to live parts for shock protection insuring compliance with OSHA, NFPA 70E, and IEEE 1584 standards. Customizable Reports and templates are available to support a safer power system design.

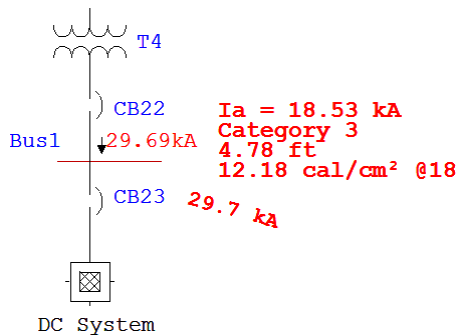

DANGER Flash & Shock Hazard with covers or doors open Appropriate PPE Required	
Flash Protection Flash Hazard Category 3 Incident Energy (cal/cm ²) 12.177 Flash Boundary Protection 4.8 ft	Shock Protection 480 VAC Shock Hazard when: <u>covers removed</u> Limited Approach Boundary 10 ft Restricted Approach Boundary 1 ft Prohibited Approach Boundary 0.1 ft PPE: Class 00 V-Rating 500 VAC
Equipment ID Bus1 Equipment Name Source Protective Device	
Contract # OTI-12345678 Engineer Operation Technology, Inc. Date 11-29-2005	
Changes in equipment settings or system configuration will invalidate the calculated values and PPE requirement which may result in a hazardous condition.	



➤ **What If Studies**

It is inevitable during emergency drills that operations will connect buses together that were not intended to be connected under normal conditions. ETAP can quickly model such conditions and determine the impact on the plant before engineers concur with any proposed changes.

11) What Users Say About ETAP Nuclear Version

"The OTI staff was found to be knowledgeable, conscientious and truly interested in continuous improvement and support of the ETAP product"

- Sargent & Lundy.

"OTI requires and conducts a post mortem review of the lessons learned during the development cycle for each version of software released. The inspectors reviewed the post mortem report for ETAP-PS version 4.7.0N. The post mortem review summarized the development work and described measures that should be considered that could improve the efficiency of the development process. The post mortem review activity was conducted by OTI upper management, and therefore, was in accordance with 10 CFR Part 50 Appendix B, Criterion I, "Organization," in that the personnel performing the post mortem review had sufficient authority and organizational freedom to identify quality problems; to initiate, recommend, or provide solutions; and to verify implementation of solutions. The post mortem review activity is also in conformance with 10 CFR Part 50 Appendix B, Criterion II, "Quality Assurance Program," in that the vendor regularly reviews the status and adequacy of the quality assurance program."

- Nuclear Regulatory Commission Report, March 7, 2003

For more information, contact nuclear@etap.com or visit our web site at www.etap.com.